



18A4SSH188

18 Foot Square Hinged Aluminum Light Pole, 4 Inch Wide, 0.188 Inch Wall Thickness

Job: _____
 Job Site: _____ State: _____ Client Name: _____
 Notes: _____ Approvals: _____ Date: _____

Pole Top Options: A removable pole cap is provided if the pole is drilled for attaching light fixtures. The drill pattern and drill orientation needs to be provided by the customer unless Energy Light fixtures are used for the project. If tenon option is selected, a 2-3/8 inch diameter tenon with 4 inch length is provided.

Pole Shaft: The pole shaft is constructed of seamless extruded tube of 6063 Series Aluminum Alloy per the requirements of ASTM B221.

Handhole: 2" X 4" size handhole with cover is located at 18 inches from the base. Ground lug is included.

Finish: Commercial grade, super durable powder coat finish. Dark Bronze is standard color. White, Black, Gray colors are provided at no extra charge. Other colors and custom color options are available at a surcharge.

Anchor Bolts: A set of 4 galvanized steel anchor bolts is provided with each pole assembly. Each anchor bolt includes 1 Hex Nut, 1 Lock Washer and 1 Flat Washer. Energy Light, Inc. recommends leveling shims instead of leveling nuts.

No grouting is required with leveling shims. Shims are available at a surcharge. An actual size paper anchor bolt template is provided.

Bolt Circle Range: 7 1/2" - 9".

Hinged Base: This aluminum light pole has a unique hinge-base design which consists of 2 bases connected with a hinge. The bottom portion is mounted on a concrete foundation with anchor bolts. The top base is secured to the bottom base with the use of 3 Stainless Steel Screws (also provided). When these 3 screws are loosened, the pole which is welded to the top base can be lowered all the way to the ground allowing access to the equipment or light fixtures mounted on top of the pole without the need of ladders or lifts.

Other Options: The following options are available: Vibration damper, custom tenon sizes, custom colors, electric/GFI outlets, custom pole heights, additional handhole and UL compliant handholes.

Warranty: 10 Years.

Foundation design: Foundation should be designed by an engineer familiar with local soil and wind conditions as well as local code where the pole(s) will be installed.

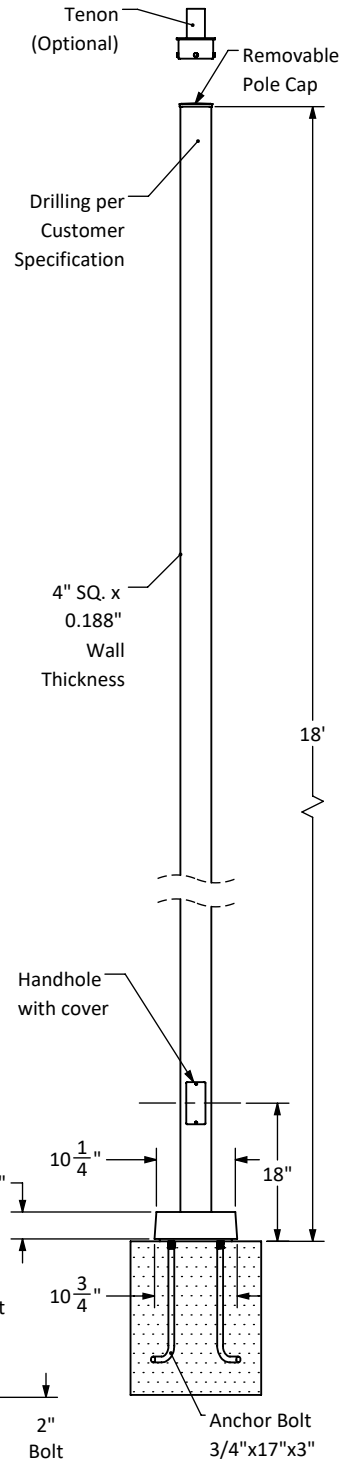

Maximum EPA with 1.3 Gust Factor (ft ²)				Pole Weight (lbs)
90 mph	100 mph	120 mph	130 mph	
5.7	3.9	2.2	1.4	74

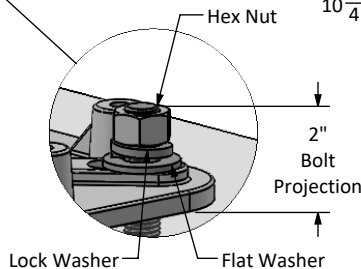
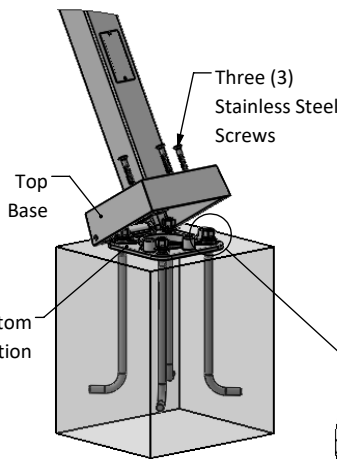
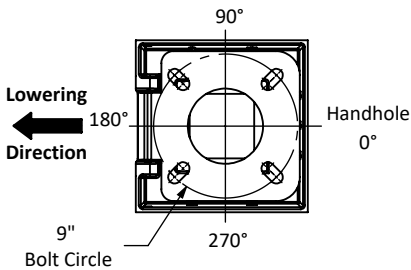

Disclaimer: All dimensions and specifications are subject to change without any notice. Energy Light, Inc. is not responsible for any claims arising from improper loading (what is attached to the light pole), improper use, incorrect foundation design and/or installation.