

H35A10RT188

35 Foot Hurricane Resistant Round Tapered Aluminum Light Pole, 10 Inch Diameter, 0.188 Inch Wall Thickness

Product Description

- Pole Top Options:** Poles are provided with either a removable top cap or an aluminum tenon. A 2 3/8 inch outside diameter tenon with 4 inches in length is the most common; however, other tenon options are available. Customers should confirm the appropriate tenon size required by their project prior to ordering. Poles with a top cap can also be drilled during fabrication. The drill pattern and orientation need to be provided by the customer, unless our fixtures are being used for the project.
- Pole Shaft:** Straight Aluminum, alloy tube wall 6063-T6, satin ground or powder coat finish.
- Handhole:** Reinforced handhole is located 18 inches from the base plate. A handhole cover with two stainless steel screws is also provided.
- Bolt Covers:** Comes with 4 Aluminum bolt covers and stainless steel hardware.
- Anchor Bolts:** This light pole includes four (4) L-shaped, fully galvanized anchor bolts conforming to AASHTO M314-90 meeting Grade 55 standards. Galvanized hardware consisting of four (4) hex nuts, four (4) lock washers and four (4) flat washers as well as one (1) paper anchor bolt template are included. For your convenience, anchor bolts can be pre-shipped for a nominal surcharge.
- Color and Finish Options:** Commercial grade powder coat is the standard option. Dark bronze, white and black, gray and green are provided at no extra charge. Other colors and custom colors options are available at a surcharge. Hot dip galvanizing is available with a surcharge and extended lead time. Powder coated, galvanized poles are also available as a premium option.
- Other Options:** The following options are available for an additional charge. Please consult one of our light pole experts for details: Vibration dampener, custom tenon sizes, custom colors, electric/GFI outlets, custom pole heights, additional handholes, UL compliant handholes and custom base plate dimensions.

Specification Table		
Mounting Height (ft.)	A	35
Wall Thickness (in.)	B	0.188
Top Diameter (in.)	C	6
Butt Diameter (in.)	D	10
Base Width (in.)	E	14
Bolt Circle (in.)	F	14.5
Bolt Projection (in.)	G	3.25
Anchor Bolt Size (in.)	H	1 x 48 x 4
Handhole Cover (in.)	I	4 x 6
Bolt Circle Range (in.)	-	14-15

Maximum EPA with 1.3 Gust Factor:		
120 mph:	17.8	Square Feet
140 mph:	12.5	Square Feet
160 mph:	9.1	Square Feet
180 mph:	6.6	Square Feet



(4) Galvanized Steel Anchor Bolts
(See Table for Details)

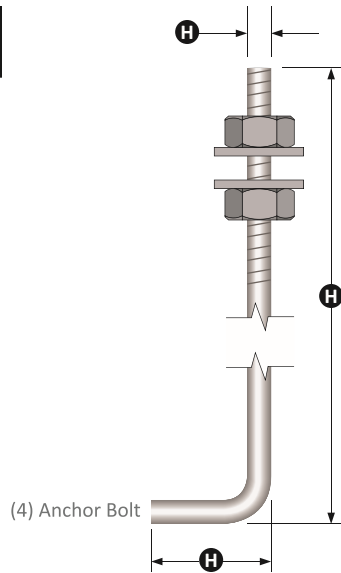
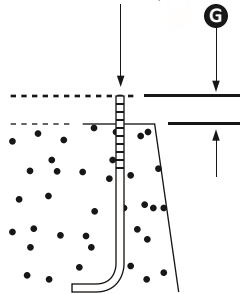

(4) Anchor Bolt

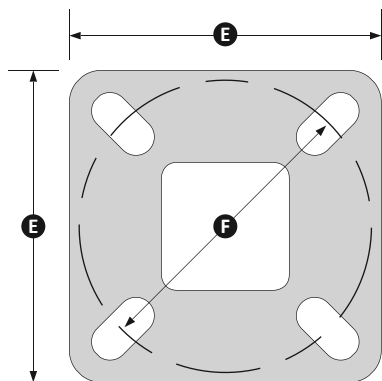

Base Plate



Bolt Covers

